

A GUIDE TO AUDIO FREQUENCY INDUCTION LOOP SYSTEMS (AFILS)

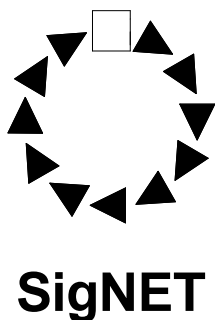

SigNET (Amplification and Control) Ltd.
Tower Road, Glover Industrial Estate, Washington, Tyne and Wear, NE37 2SH.
Tel: 0191 417 4551 Fax: 0191 417 0634
Email: info@Signet-ac.co.uk
Web: www.Signet-ac.co.uk



Introduction.....	3
What is an induction loop	3
How it works.....	3
Applications.....	5
The Disability Discrimination Act.....	5
Building Regulations	5
Types of Induction Loops and Considerations.....	6
The AVX range of induction loop amplifiers	6
PDA101.....	7
PDA200 & PDA800	8
PDA200E	8
PDA500 & PDA1000	9
Microphones	10
Choosing the Correct Induction Loop Equipment.....	11
Room / building layout	11
How to work out the induction loop current requirements and cable size.....	12
Peak current calculation.....	12
Cable type and size	13
Induction Loop Design and Installation	15
Ferrous metal	15
Unwanted radiation.....	15
Low spill over (cross-talk) systems	15
The ‘electric grill shape’	15
Multiple loop patterns.....	16
Non – rectangular rooms	17
Fixed tables.....	17
Vertical loops.....	17
Buildings and Room Differences	18
Flat ceilings, sloping floors and suspended ceilings.....	18
Installation under a carpet.....	18
If the area to be covered is bigger than can be covered by a single amplifier.	19
Loop system coverage.....	19
Testing an Induction Loop	19
Test run	19
Dead zones	19

Introduction

What is an induction loop

An Audio Frequency Induction Loop System (AFILS) comprises a cable in the form of a loop connected via an amplifier to one or more sources of sound signals. In simple terms an AFILS can be compared to a transformer with the loop cable as the primary and the hearing aid as the secondary.

The amplifiers manufactured by SigNET are constant current drive and specifically designed for AFILS, they produce an audio frequency electric current in the induction loop cable, causing a magnetic field to be produced. This magnetic field is a reproduction of the signal feeding the amplifier and can be picked up by suitable receivers, such as the SigNET RXTI or hearing aids equipped with a 'telecoil' and an 'M-T' or 'M-MT-T' switch.

Below is a simple diagram of a loop system, loop layouts may often be more complicated depending on the environment.

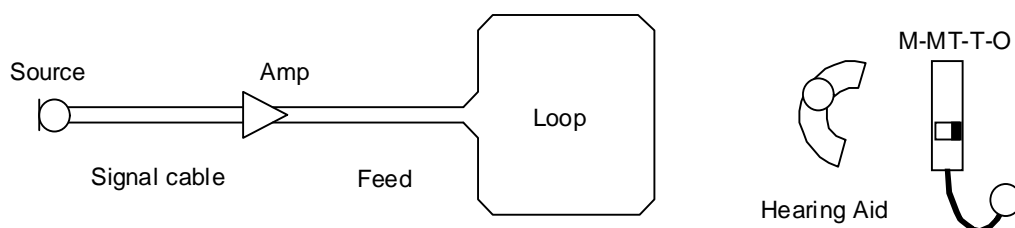

How it works

An AFILS does not use radio frequencies; it operates at audio frequencies.

The signal from an audio source is fed into the induction loop amplifier, which amplifies and sets the signal level in the same way as any other amplifier. The amplified signal, instead of going to a loudspeaker, is fed to a closed loop of cable that is normally placed around the perimeter of the room to be covered. Employing a constant current amplifier ensures that current is maintained at the set level whilst providing a flat frequency response without the need for equalisation circuitry.

The current flowing through the loop generates a magnetic field at audio frequency that radiates in the space around the loop cable (see diagram below). Any lines of magnetic flux that pass through the coil in a receiver, such as a hearing aid, will generate a current in that coil that is then converted back to audio and fed into the listener's ear. It is important to remember that the magnetic field will 'bleed' **outside** the perimeter of the loop (by up to 3 times the width of the loop in certain cases) and therefore an AFILS cannot be considered a confidential system. Ways of reducing this bleed or cross-talk are addressed in the section 'Induction Loop Design' later in this document.

Magnetic field in a plane through one axis of a rectangular loop

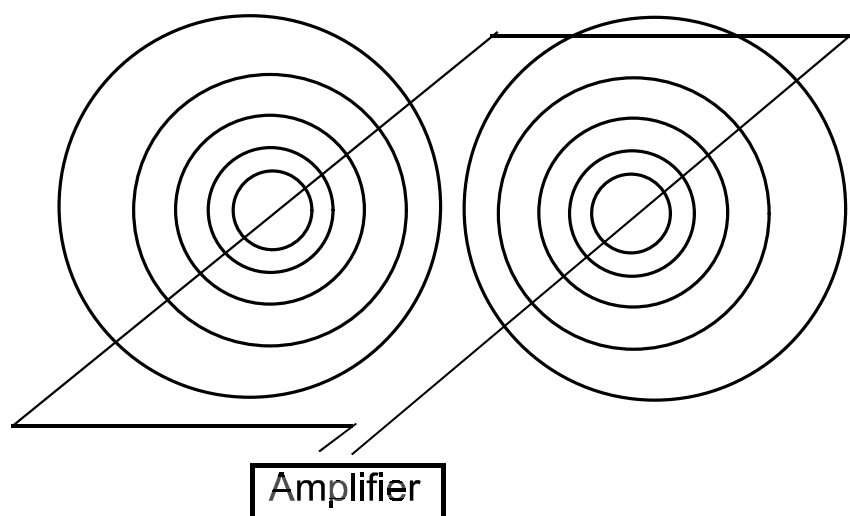

Why we have induction loop systems

Hearing aids in the M position utilise an omni-directional microphone for amplifying localised speech. Whilst these are effective for local conversations in reasonably quiet environments they are less than effective for listening to speech or music at a distance or other problem areas such as the security screen found at most ticket counters. This is because the aid's microphone picks up the wanted sounds compressing these together with the general noise and reverberation of the room and unwanted speech of other conversations. If the required sound can be supplied directly into the hearing aid then the unwanted sounds are excluded or reduced. An induction loop system can provide this by moving the required source closer to the hearing aid user using microphones PA etc.

Applications

The Disability Discrimination Act

Below are the key dates in which DDA legislation was or is to be implemented. The act was introduced to end discrimination against disabled people whether they are employees or service users.

By a service provider or employer installing an induction loops system, then this is one way in which they could meet legislation with regards to the hard of hearing.

02/12/96 First rights of access came into effect and placed a duty on service providers not to refuse service to disabled people; offer a worse service; or offer service on worse terms for a reason related to the person's disability.

01/12/98 The employment provisions of the DDA extended to employers with 15 or more employees.

01/10/99 Service providers required to make reasonable adjustments to policies, procedures and practises which exclude disabled people, provide auxiliary aids and services.

01/10/2004 Where there is a physical feature that makes it impossible or unreasonably difficult for a disabled person to make use of a service, service providers will have to take all reasonable steps to remove, alter or avoid it if the service cannot be provided by a reasonable alternative method

01/10//2004 The employment provision threshold of the DDA will be lowered to companies of 2 or more personnel

The DDA now has greater force to cover existing and historic buildings.

Building Regulations

Part M2 "Access and use" requires an 'aid to communication' to be installed in certain circumstances for new buildings or those undergoing extensive refurbishment. Building regulations call for an assisted hearing system for public and staff in meeting rooms and reception areas over 100m² and at glazed ticket offices.

BS 8300 : 2001

The design of buildings & their approaches to meet the needs of disabled people—
Code of Practice

Audio Frequency Induction Loop systems (AFILS)

The following standards govern the use of AFILS:

EN60118-4 (IEC 118: Part 4: 1981)
formerly BS6083 part 4: 1981
BS7594: 1993

Types of Induction Loops and Considerations

The AVX range of Induction loop amplifiers

SigNET's PDA range of induction loop systems is one of the most popular in the country, offering top quality sound, simple installation and proven reliability.

Area size/type	Required Model
Ticket counters and reception desks	PDA101C
Areas up to 50m ² (absolute maximum)	PDA101L
Connection to a TV via a SCART connector in areas up to 50m ² (max)*	PDA101S
For areas up to 120m ² For wall mounted amplifier or multi – input applications	PDA200 PDA200E
For areas up to 400m ²	PDA800
Professional rack mount installations in areas up to 250m ²	PDA500
Professional rack-mount installations in areas up to 550m ²	PDA1000

**NEVER connect to any internal circuits in a TV as very high voltages can be present, even on loudspeakers,.*

1. PDA101

For ease of installation, the PDA 101 is available in the following formats:

PDA101L: Includes everything needed to create a microphone - based induction loop system of up to **50m²** - an amplifier, a BS415 approved power system, a microphone and **30m** of loop cable.

PDA101S: Designed specifically for use in bedrooms and TV lounges, this kit includes an amplifier, power supply, SCART lead (for connection to TV) and **30 m** of loop cable.

PDA101C: Ideally suited for use in ticket offices, bank counters and on desktops, this package includes an amplifier, power supply, microphone and a tx121 counter loop. The tx121 plugs into the loop socket to create a restricted field up to two metres wide. Dimensions: (W) 95mm, (H) 55mm, (D) 110mm.

Example use - Ticket counters

Use the PDA101C, which comes complete with a PDA100M self-adhesive electret microphone on a one metre unbalanced lead. This cable will pick up interference if it is extended and so it is generally only suitable for use on ticket counters or as a direct pick-up from a TV loudspeaker.

Fix the mic to the front edge of the counter, bearing in mind that clothing should not rub up against it, as this will be transmitted.

In order to minimise the risk of eavesdropping, it is normal to fit induction loop systems at every other counter position.

If the PDA101M is not suitable, use a JHM1 gooseneck mic fitted to one side on the desktop.

The ideal location for the counter loop is horizontally just under the counter top.

If the counter is very high, such as in a bookmaker's, experiment with fitting the loop lower.

Domestic use, bedrooms in nursing homes

The loop has two typical applications. Relaying TV sound and conversations with visitors.

For TV sound only, use the PDA101S and plug into the TV.

For conversation only, use the PDA101M mic supplied.

If TV and conversation are required at the same time, position the microphone near to the loudspeaker and the room's occupants, say on the front, top or bottom of the set.

2. PDA200 & PDA800

Many of the features of the PDA 500 and 1000 but are designed for use in smaller buildings such as offices, factories and nursing homes where ease of installation and simple operation are just as important as sound quality.

SigNET's unique floating sense system able to provide a flat frequency response from as low as 20 Hz up to the recommended maximum of 16 kHz, providing excellent audio quality at a surprisingly low cost.

Microphone or line level input to both units is via two 5 pin DIN connectors, both of which can be easily adjusted via the amplifier's front panel level controls.

An automatic tracking compressor compensates for poor microphone technique, whilst an intelligent system controller provides the high peak current capability required for natural sounding reproduction at the output stage.

Covering respectively, the PDA 800 and 200 include 'alert' trigger inputs for connection to fire alarms, burglar alarms or doorbells to provide an audible warning in the loop of possible danger or a visitor.

An 'X - Talk' facility is also available allowing either amplifier to be connected to SigNET's impulse 75 mixer amplifier. This allows the inputs from both units to be shared to create the ideal PA / loop amplifier combination for churches, schools, and meeting rooms.

- Free standing cases with recessed controls to prevent tampering
- Input level peak LEDs
- Output current meter.
- Can be connected to a SCART socket using **PDA2-8S** lead

Dimensions: (W) 305mm, (H) 72mm, (D) 200mm

3. PDA200E

The PDA200E shares the superb audio quality of the 200 but is wall mounted, it has audio inputs from balanced /unbalanced microphone and balanced /unbalanced line level inputs such as CD player, mixing desk. The unit also contains a dedicated input for 100V line (from a PA system) plus an alert trigger for use with doorbells and fire alarms.

The front fascia has five external indicators including three peak current indicators, however there are no external controls providing impressive tamper resistance.

Whilst the unit has direct inputs more inputs can be added by using outreach plates for a number of variations of inputs. Plates can be purchased separately or in a kit form, each kit contains mics (if needed), outreach plates, amplifier, loop cable and all connecting cables.

Applications: Schools; factories; Nursing Homes; Sports Centres; Town Halls; Offices.

Typical use - Nursing Home Lounges

The loop has two typical applications. Relaying TV sound and entertainment / announcements.

For TV sound, use an APS SCART lead connected direct to the 200E or via an APL outreach plate.

For a fixed microphone, fit an APM to the ceiling (fits in 25mm single gang electrical back box) over where the speaker normally stands.

For a handheld microphone, use an AMH handheld microphone.

For overall sound pickup, use 2 off APM on the ceiling about a third of the way from each end of the room.

4. PDA500 & PDA1000

Model	Short term peaks
PDA500	Up to 12 Amperes
PDA1000	Up to 17 Amperes

Features

- Both are 19" Rackmount
- Power supply circuit provides enough power for the most demanding of music and speech signals such as theatres and conference centres.
- A studio compressor and expander circuit tracks and controls the input signal over a 100 dB dynamic range. Although the signal is constantly monitored, transient peaks are only controlled when necessary, as it is the shape of the sound that conveys emotion and feeling.
- A 'duck' facility is also available to convey audience response and prevent the claustrophobic effect of no ambient noise in theatres and churches etc.
- Two balanced microphone or line level outputs
- XLR connectors
- Output current metres
- Input level peak LEDs to assist setting up.

Dimensions: (W) 482mm, (H) 88 / 44mm, (D) 243mm

Applications: Theatres; Bingo Halls; Churches; Cinemas; Court rooms; Conference Centres; Offices; Stadiums.

Typical use - Churches

Apart from the smallest halls, churches generally need microphones at different positions such as the pulpit, the altar, the choir, etc. Installing, cabling and mixing these microphones is relatively expensive and specialised.

For most installations, especially if there is no specification, the ideal solution is a radio microphone.

Radio microphones are normally provided as lapel mics or handheld.

We suggest the SigNET AMR kit or the EW165 (handheld mic) four channel systems.

If more complex microphone systems are required, a multi-channel mixing desk will be required, such as the Spirit RW5354 (4 balanced mic, 2 stereo inputs) or the RW5445 (6 balanced mic, 2 stereo inputs) both available from SigNET.

Note on Church Loops

If the whole church is covered with a simple loop then overspill will be heard outside. A sign can be put at the exit telling users to turn the hearing aid back to mic as they leave the building.

If a mixing desk is to be fitted, it is possible for magnetic interference to occur at the input connectors. This can be minimised by running a 1 x 1 meter notch in the loop where the desk will fit.

Microphones

Many designs of microphone are available for specific applications and they can cost anything from a few pounds to several *thousands* of pounds. Only reasonably priced microphones are required for loop amplifiers.

Capacitive or electret microphones have the highest tolerance of magnetic feedback and are recommended, dynamic microphones should be avoided.

A PDA101M self-adhesive electret microphone on one metre unbalanced lead is supplied with the PDA 101C/L and come with desk mount or lavalier fixings

When deciding which microphone to use for a particular application, the following guide should prove useful. (All of the products listed should be available from your local distributor).

Type of microphone and example application	SigNET	Audio - Technica
Conference table (for the centre of meeting tables etc)	APM	PRO 49
Lecturn (for pulpits, lectures, etc)	AML	AT857
Lavalier (for the lapel of an after dinner speaker)	AMT AMR (radio mic)	AT851A
Ambient mic (for audience response etc)	APM	PRO 49
Ceiling (can be hidden in the ceiling above a conference table)	APM	AT845R
Handheld Condenser	AMH AMR (radio mic)	MB400C

Microphone Cables

Good quality microphone cable should be used. Suitable cables are available from RS components.

For example, stock number 361-557 is a 100-metre reel of PVC insulated cable with good screening and flexibility.

If there is a high risk of electrical interference, stock number 236-9068 is a 100-metre reel of PVC insulated star-quad microphone cable with increased noise rejection.

Cable should be sited a minimum of 1 metre vertically above or below the loop cable where the field is at a minimum.

Choosing The Correct Induction Loop Equipment

Room / building layout

There might be reasons why it is difficult to install the cable at floor or ceiling height. It is important to know that if the cable is run on the wall around ear height it will give the strongest possible field. As the listener approaches the loop cable, the signal will be uncomfortably strong near to the loop. Therefore great care should be taken not to install a loop cable closer than 1.2M from the hearing aid location.

In the region directly above or below the loop cable, the signal will drop to zero. This is because there is little or no vertical component of the magnetic field in this region however this is usually undetectable by the hearing aid wearer.

Cable can be chased into walls, fixed behind a dado rail or painted to match the surroundings. In certain cases flat wire tape can be fixed underneath carpets with adhesive tape.

Important: Do not short the loop to earth as this will cause failure of the amplifier and cannot be protected against electronically. Common examples are shorting a floor loop to a reinforcing grid, or a wall loop to a pipe

How to work out the Induction Loop current requirements and cable size

Loop Current

In an Induction loop system the current created by the amplifier is responsible for producing the magnetic field, therefore care should be taken at the installation stage to produce an adequate current and a satisfactory magnetic field for the user of hearing aids.

As nearly all loops are approximately square or rectangular, the amount of current required to produce a particular strength of magnetic field at the centre of a single turn loop is given by the following formula :-

$$I = \frac{H \pi AB}{2D}$$

H = required field strength (A/m)

A,B = lengths of sides (m)

D = length of loop diagonal (m)

Peak current calculation

To calculate the required current it is first necessary to calculate the aspect ratio of the loop. This is the width of the loop divided by the length of the loop, assuming the loop approximates to a rectangle. Circular loops should be approximated to a square. If the room is L - shaped, assume it is a square or rectangle and use the longest side and the longest width. (For this case, the calculated peak current required will be too large, so reduce the drive level slightly) It is also necessary to know the total length of the loop cable. If the connecting cable from the amplifier to the loop is the same cable as used for the loop, then this should also be included.

The calculations below assume that the loop will be approximately the same level as the receiver. (Vertical displacement) If the loop is significantly higher or lower (more than one to two metres) than the receiver, then the peak current required will be slightly higher.

Peak current against loop width for differing aspect ratios. (a)

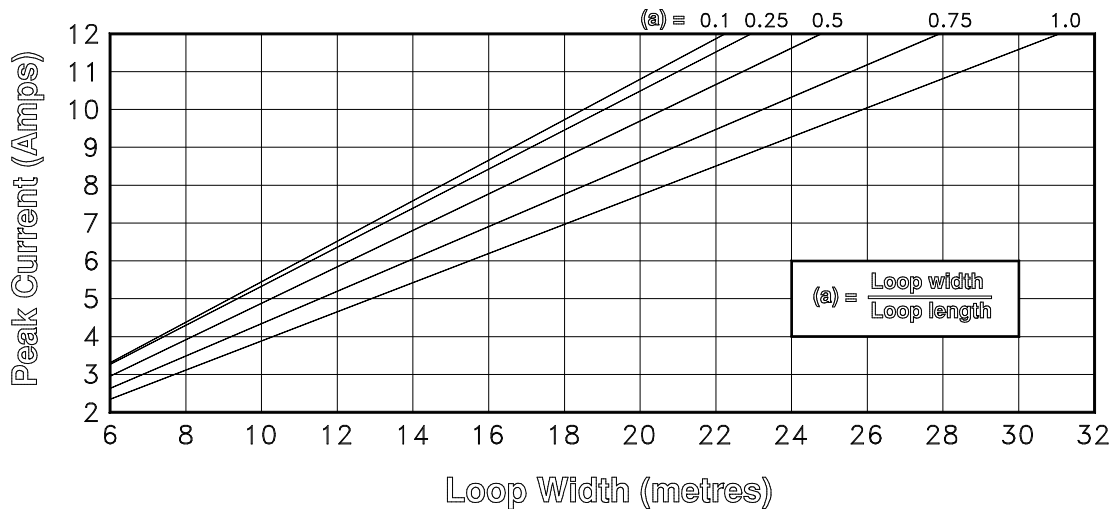

Refer to the current width- graph to establish the required peak current. The width of the loop is shown on the x-axis. The peak current is shown vertically on the y-axis. This is the peak current. **The average current output should be approximately one quarter of the maximum peak.** Move along the x-axis until you come to the width of your loop, then move up until you come to one of the aspect ratio lines. From this point, read the peak current required. The D.C resistance of the loop should be between 0.2 Ohms and 2 Ohms. It is very unlikely that any loop will be less than 0.2 Ohms as this is virtually a short. It is quite acceptable to have a D.C resistance greater than two Ohms, but full current drive may not be possible.

Cable type and size

A loop cable is classed as a 2A cable under IEEE 16th Edition wiring regulations. As such it must be sited a minimum of 600mm away from telephone, mains and control cables.

Almost any stranded or solid single core cable can be used for the loop, provided it is not liable to break and is of the appropriate gauge.

The cross-section should be chosen so the loop is as near to one ohm as possible (0.5 to 1.5 ohms) and robust insulation is recommended to minimise the chance of shorting the cable to earth (which will destroy the output of the amplifier).

If the impedance is less than 0.2 ohm or greater than 2 ohm there may be degradation of signal.

We recommend tri-rated switchgear cable, which is available from RS components.

Cross section area	Stock number	Outside diameter
0.5 mm	364-253	2.6 mm
0.75 mm	364-326	2.9 mm
1.0 mm	364-398	3.1 mm
1.5 mm	364-461	3.4 mm
2.5 mm	364-534	3.8 mm
4.0 mm	364-607	4.4 mm
6.0 mm	364-657	5.1 mm

To obtain the correct impedance, there follows a guide of recommended cable diameters for PDA amplifiers, a wire impedance chart and example calculation.

Amplifier	Recommended cable gauge
PDA100	0.5mm ² - Supplied
PDA200/200E	1.0mm ²
PDA500	1.0 - 2.5mm ²
PDA800	1.5 - 2.5mm ²
PDA1000	2.5 - 4.0mm ²

NOTE: Do not use cable outside the recommended gauges

Cable Diameter	Impedance per km	Optimum lengths
0.5mm ²	34.3 Ohms	
1mm ²	14.7 Ohms	Up to 70 metres
1.5mm ²	11.2 Ohms	70 - 100 metres
2.5mm ²	6.7 Ohms	100 - 165 metres
4mm ²	4.5 Ohms	165 + metres
6mm ²	3.0 Ohms	

Example calculation:

Cable impedance =

Length of loop / 1000 x impedance of cable per km.

For a PDA800 covering 380 m². Cable length = 79 metres

79 ÷ 1000 x 11.2 (impedance per km of 1.5mm² cable)= 0.88 Ohms

79 ÷ 1000 x 6.7 (impedance per km of 2.5mm² cable)= 0.52 Ohms

For this example, 1.5mm² cable would be the preferred option as its DC impedance is nearest to the recommended level of 1 Ohm.

Induction Loop Design and Installation

Ferrous metal

Induction loops produce a magnetic field, in a building containing steelwork both the field strength and frequency response of the loop will be adversely affected. Whilst steel girders appear to have little effect on the signal, care should be taken around steel mesh reinforced floors or metal ceilings to place the loop cable as far away as possible from the metal.

Unwanted radiation

Magnetic fields radiated from mains cable and equipment can be detected in most buildings on a hearing aid switched to 'T'. Serious interference can be caused by the separation of live and neutral or phase conductors of mains circuits which is particularly found in old buildings where the wiring has had a lot of alterations. This also occurs in modern buildings where loop circuits have been installed for fluorescent lighting with an interlinked neutral.

Low over spill (cross-talk) systems

The magnetic field is not confined to the area within the loop. Special designs of loop can reduce the overspill field. However well an AFILS is designed it will always be possible for a determined person outside the intended area of coverage to listen in.

The British Standard suggests several technically complex solutions that are reasonably effective, but are rarely employed due to high cost. In many cases overspill can be reduced nearly as effectively, and for much less cost by laying the loop in an 'electric grill' pattern where each leg of the cable is about 2 metres from its neighbour.

This method cannot be used in small rooms, where we suggest a 2 metre square loop in the centre of the room.

The receiving coil in a hearing aid only responds to the vertical component of the magnetic field round the loop cable. Immediately above the loop there is no vertical component so there will be a dead spot. However, unless the loop is a long way above or below the listener, this area will be very narrow and it is often an acceptable compromise in return for reduced overspill.

The 'electric grill' shape.

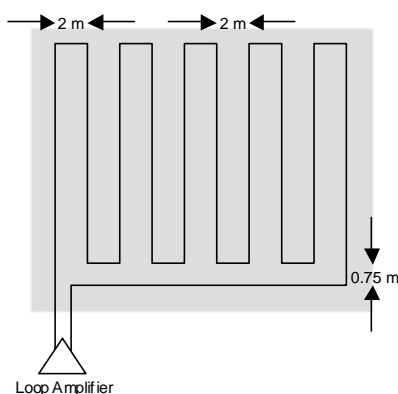

This is one of the most common loop layouts and is usually laid beneath a carpet using copper flat loop tape, however it works equally well laid above a suspended ceiling. The gap between the 'prongs' of the pattern is about 2 metres because this reduces the

overspill (left - right in the diagram) to about six metres but allows the field to spread upwards enough to give good coverage at head height. This uses the fact that lines of magnetic flux cannot cross each other to squash the field in the vertical and horizontal planes.

The up - down overspill as shown in the diagram will be slightly more than the left – right spill but will still be a lot less than for a simple rectangular pattern.

A loop pattern laid on the floor is a low cost method to reduce over-spill and provide more even field strength compared to the usual single turn of cable laid around the room’s perimeter.

The downside of this pattern is that a ‘dead’ spot will exist immediately above each cable, but this compromise is usually not noticeable.

The area of the loop is the overall length x the overall width, but the perimeter is total length of the cable. This means that a larger cross section cable may be required than for a rectangular loop. Assume the cable is being run around the edge of a room for cable diameter calculations

Break into the pattern as shown to connect the PDA unit.

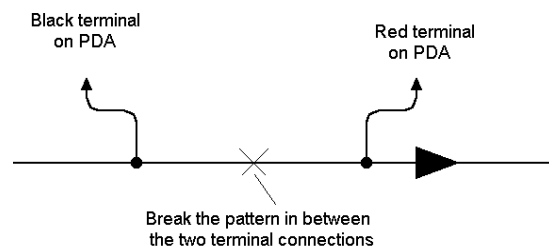

Multiple loop patterns

To cover large areas or multiple rooms use several loop patterns, each pattern must be connected to a separate loop amplifier. When laying out patterns, ensure each is 90 degrees out of phase with its neighbours as per the following diagram:

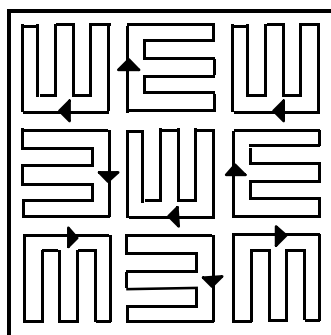
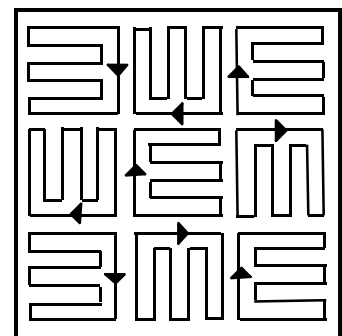

Level 2

Note. For a two storey building the *same* loop position on different floors is also 90 degrees out of phase.

Non-rectangular rooms

Layout as per a basic pattern and step back the prongs to the shape of the room.

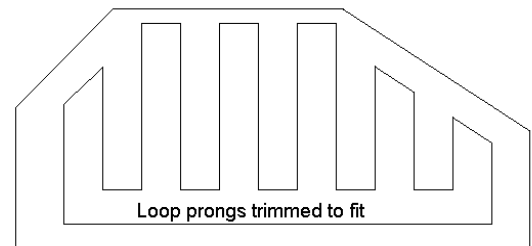

Fixed tables

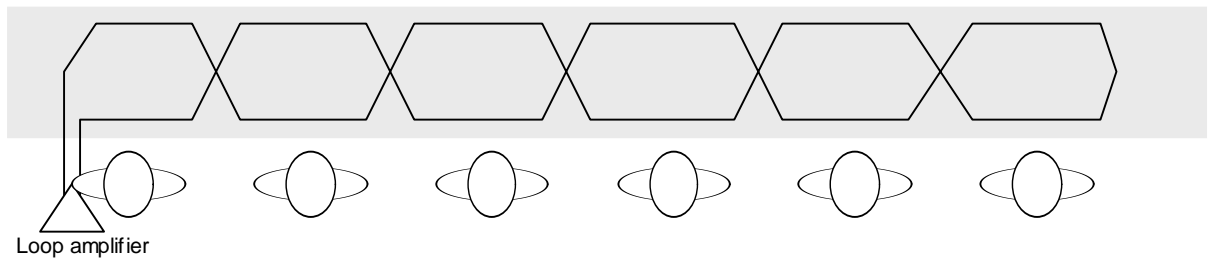

This pattern restricts the loop to the immediate vicinity of the table and, depending on the layout, there should be little or no overspill outside the room.

The area of the loop is the overall length x the width, ignoring the shape of the pattern.

The perimeter is the actual cable length and this may result in a larger cable diameter being required than for a rectangular loop.

Vertical Loops

Virtually all loops are laid in the horizontal (as around the skirting board) this is due to the directional response of the hearing aid (see diagram below) but in an application (such as a hospital) where the hearing aid wearer is predominantly horizontal then no signal will be received. It is therefore necessary to run the loop cable at an angle of 45 degrees from floor to ceiling as this will allow the hearing aid to cut across the plane and receive a signal.

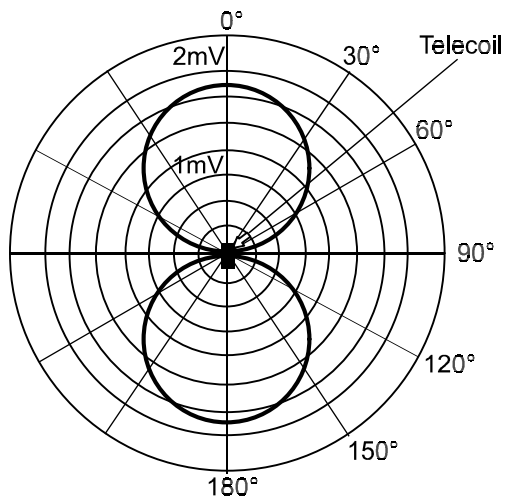

Directional response of a hearing aid telecoil

Please note: All of the above are guidelines only; we *always* recommend a test loop should be laid as there is no such thing as a basic installation. Each job will be unique and will have its own problems or criteria (for example metalwork, reinforced concrete, false ceilings etc.)

Building And Room Differences

Flat ceilings, sloping floors and suspended ceilings

For flat ceilings and sloping floors, such as those found in theatres and cinemas, try to run the loop at the same angle as the floor, perhaps behind a handrail (if one is available) to ensure the signal is distributed evenly throughout the building.

If the ceiling has a metal grid and non-metallic ceiling tiles, simply tie-wrap the loop cable to the support wires a couple of centimetres above the tiles.

If the tiles are metallic, the field strength will be affected, even if they are perforated, and especially if they are electrically cross-bonded. It may be possible to partially overcome this by turning up the current drive of the amplifier, please check with your supplier.

Installation under a carpet

SigNET supply three sizes of flat tape, each 66 metres long. They have cross sections of 0.5 mm^2 , 1.0 mm^2 , and 1.5 mm^2 .

Use protective tape to hold the cable down and this also reduce the chances of damage.

If the area to be covered is bigger than can be covered by a single amplifier

Consult your supplier for advice. One method is to run two cables and two amplifiers in parallel; another is to lay special patterns of cable adjacent to each other.

Loop system coverage

Loop systems do not necessarily have to cover the whole area, for instance in a bowling alley, it will only need to cover the top of the lanes and in a church it will only have to cover the pews, although it might also have to cover the choir.

Testing An Induction Loop

Test run

A trial loop should be run, wherever possible and the layout adjusted to suit. This will verify that the system is operating as planned and is recommended by BS7594.

The cable can be stuck in place temporarily with 'gaffa' tape and a simple performance test carried out.

To do this, set up the loop and listen to the signal with either a standard hearing aid or a dedicated loop receiver, such as SigNET's RXti 2.

If there are areas of good coverage and poor coverage users should be informed so that arrangements can be made to avoid these black spots.

If loops have to be placed next to each other so close that overspill cannot be avoided, such as in bedrooms, it may be necessary to advise the client that adjacent loops cannot be used at the same time.

On new-build projects it will probably not be possible to run a trial loop. If you are in doubt about the design layout, we suggest sending dimensioned sketches showing any adjacent loops to your supplier for advice.

Dead zones

If full coverage of the area required cannot be achieved refer to BS BS7594. This says that some installations will be a compromise and that dead patches may be unavoidable.

Again testing can be carried out using the RXti, which can show the extent of any dead patches.